

# ACCÉNT Glass Whiteboard

The modern frameless alternative to traditional whiteboards



Magnetic

Dry Wipe

5 Year Warranty

Ultra White Glass

Concealed Mounting

Using a direct to wall mounting system with no visible fixtures and no holes in the glass, the Accent Glass Whiteboards presents a seamless writing surface to compliment your work environment.

The toughened safety glass is low iron content providing a true ultra white colour. Polished edges and smooth corner tips provide the quality finishing touches. Galvanised steel backing allows Glassboard™ magnets to be used to attach your paper notes. The non-porous glass will provide years of easy quick clean - no ghosting writing surface.

- Concealed easy wall mounting landscape or portrait
- Toughened Ultra white 4mm safety glass
- Polished edges and rounded corners
- Magnetic surface
- Includes perspex pen tray 250x60mm
- 5 year warranty
- Easy installation with drilling template and fixings

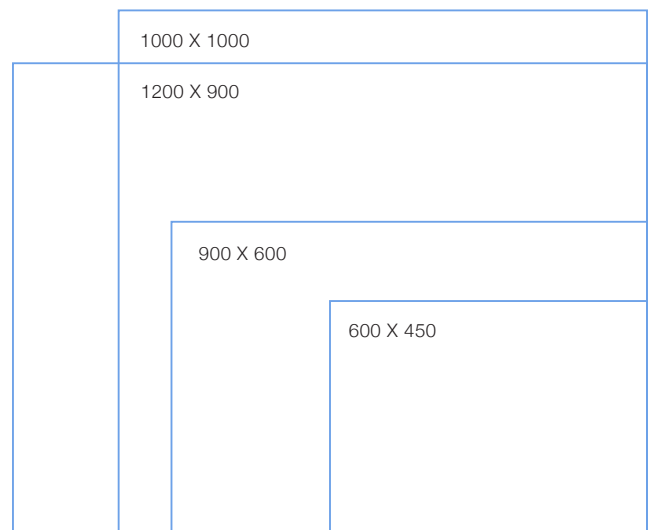

Code	Description	Size (mm)
VGA6045	Accént Ultra White Glassboard	600 x 450
VGA9060	Accént Ultra White Glassboard	900 x 600
VGA1010	Accént Ultra White Glassboard	1000 x 1000
VGA1290	Accént Ultra White Glassboard	1200 x 900

## Easy installation using template

1. Place paper template on back of glassboard and mark holes

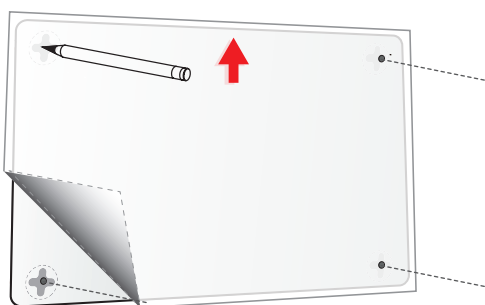

2. Stick template on wall and drill holes, insert wall plugs & screws

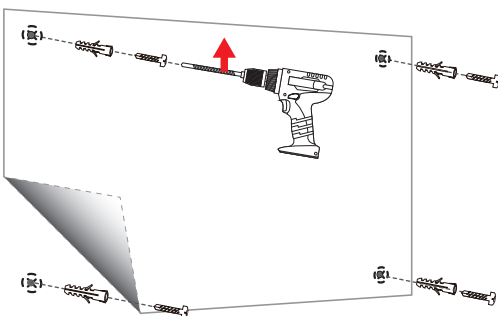

3. Stick pen tray to rear of board and screw in fittings

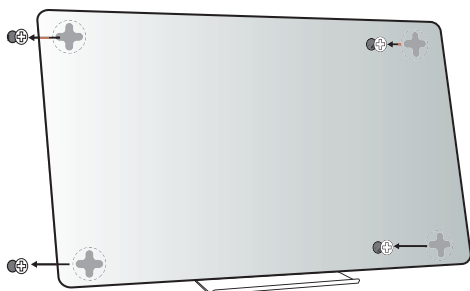

4. Position holes over fittings and pull down into place

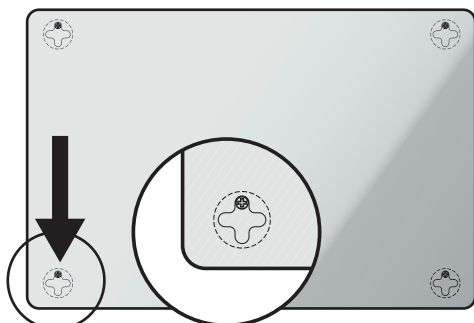

## Superior packaging for hassle free shipping

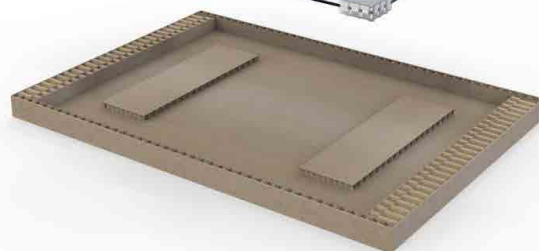
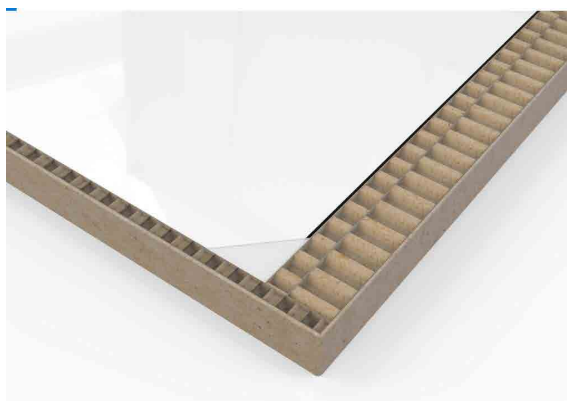

### NSW Head Office

5 Liberty Rd,  
Huntingwood,  
NSW 2148

### QLD

17 Moonbi Street  
Brendale  
QLD 4500

### VIC

U13, 69 Mark Anthony Dr,  
Dandenong South  
VIC 3175

### WA

47 Abbott Road,  
Perth Airport  
WA 6105

### SA

6 Leeds Street,  
Woodville North  
SA 5012

### NZ

423 East Tamaki Rd,  
East Tamaki, Auckland  
NZ 2013